

Rafał BUDZIŃSKI<sup>1</sup>

## NUMERICAL ANALYSIS OF CABLE NET STRUCTURE WITH APPLICATION OF DIFFERENT PRETENSIONING METHODS

Tension roofs based on cable systems are suitable for covering long span buildings. Such structures are considered to be economic, modern and aesthetic solutions in various multi-functional arenas. Development of materials and construction technologies resulted in an increased number of applications of cable systems in recent years. However, the origin of such structures dates back to 1953, when the cable net supported roof over Raleigh Arena in North Carolina was completed. Designed as self-balanced, the system was eventually pretensioned in order to provide greater stiffness. This implementation became an indispensable part of cable nets construction. A unique method of pretension was applied in one of the first and most recognizable Polish examples of tensile structure, which is the cable net roof over the open-air theater in Koszalin. The system was pretensioned through the outward rotation of simply supported edge arches, which induced tensile forces in roof cables. This simple and effective concept became an inspiration for the introduced study, which focused on the numerical application of such a solution. In this paper, the results of comparative finite element analysis of introduced cable net structure with different methods of pretensioning are presented. The investigation was preceded by the analysis of net shape, concentrated on the value of cable sags in the saddle point of parabolic hyperboloid surface. Effectiveness of the presented solutions was assessed through comparison of internal forces distribution and model deformation. Numerical verification of consecutive concepts led to a gradual reduction of directly prestressed members from 16 suspension cables to 6 cable stays in the analysed roof.

**Keywords:** tensile structure, parabolic hyperboloid, long span roofs, structure shaping

### 1. Introduction

The beginning of the 21<sup>st</sup> century brought a dynamic increase of public investments in sport and cultural infrastructure in Poland. This trend is represented by numerous structures built from scratch as new facilities or as

---

<sup>1</sup> Rafał Budziński, Rzeszow University of Technology, Department of Building Structures, 2 Poznańska Street, 35-959 Rzeszów; tel. 178651610; r.budzinski@prz.edu.pl. <http://orcid.org/0000-0002-9890-845X>

a modernization parts in existing venues. Functional and utility requirements for such projects impose a set of attributes that a design should incorporate. These necessities indicate the development of technical solutions that can be effectively implemented in modern arenas. Some major investments in recent years showed an increasing number of applications based on tensile structures, which are successfully implemented in long span buildings. These type of structures gained favor in terms of aesthetics, modernity and economics as a solution for roofs in covered stadiums, sports halls or various multi-arenas [1–5].

Cable roof structures, which are considered as tensile structures, appear in various arrangements. They can be supported by different systems based on:

- simply suspended cables (Fig. 1.a),
- pretensioned cable beams (Fig. 1.b),
- pretensioned cable nets (Fig. 1.c).

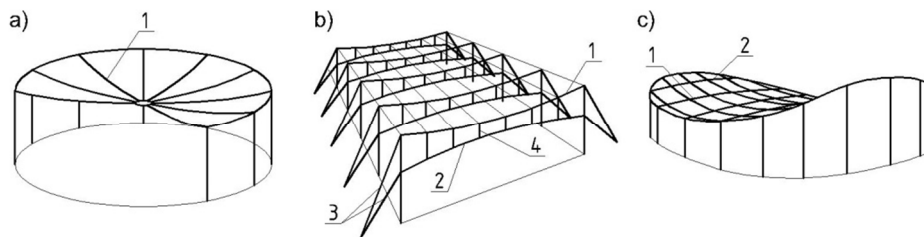

Fig. 1. Examples of different types of tension roof structures (description in the text):  
1 – suspension cables, 2 – pretension cables, 3 – stays, 4 – ties

The first two could be designed in different arrangements, which generally comes to radial and parallel planes (Fig. 1.a-b). The last of the mentioned types is based on a cable net, which takes the shape of second order surfaces (Fig. 1.c). This kind of structure, as well as the cable beams, must be pretensioned. In such cases, the pretension provides balance in the static model, which consists of two sets of cables. The suspension cables are intended to transfer loads, while the pretension cables with opposite curvature, ensure stiffness of the system. The general idea of pretensioning the cable structures comes from their high flexibility. The intensity of pretension forces should be adjusted to provide balance and proper stiffness in a specific system [1, 2].

The concept of pretensioning was successfully implemented in one of the first most recognizable tensile structures, which is Raleigh Arena in North Carolina, USA. The structure of the building, which was completed in 1953, was not intended to be primarily pretensioned. The operation was performed to counteract large deformations, which was followed by intrusive noises [6]. Latter studies of such systems helped to develop various solutions in the cable based systems, built in many countries. Apart from the recent expansion of tension roof structures, there has been few examples that can be considered as pioneering applications of such systems in Poland. The roof over the open-air

theatre in Koszalin is one of the representative cases of a pretensioned cable net system. The structure was designed in the shape of parabolic hyperboloid, comparable to the previously discussed arena. However, in this case, the pretension forces were applied through a unique method. The tensioning of the roof cables was achieved by the external rotation of simply supported edge arches, controlled by shortening the cable stays [3–5]. The structure was completed in 1975 and still fulfils its function. This design problem was studied and solved on the grounds of model experiments and partial numerical calculations [3, 7].

Analytical study of the behaviour of cable structures is a complex problem, in which the intensity and method of pretension are followed by many other variables. The complexity of such designs is escalated by the non-linear behaviour of cable members. Furthermore, the response of a certain system is influenced by the flexibility of edge structure. The assumption of ideally rigid supporting members might lead to unreliable results in terms of internal forces and deformations [1, 2]. Various analytical methods evolved and were applied throughout the history of cable roof structures [8]. Recent development of numerical analysis software gives opportunities to solve such design problems. These programmes provide tools for investigating sophisticated cable-based structures with a multi-parameter approach [3].

The aim of this article is to present results of analytical study, in which various simulations of cable pretensioning were performed in several numerical models of a cable net structure. The major part of the analysis was focused on the numerical application of pretensioning method inspired by the completion of the open-air theatre roof in Koszalin. This solution is further referred to as “indirect pretensioning”. The study of this phenomenon was preceded by the net shaping analysis. The selected geometry formed the basis for models in the main part of the study, in which indirect pretensioning was applied. The assessment of the introduced solutions was based on the comparison of numerical analysis results, which are represented by several diagrams and summary of internal forces and deformation.

Although the case of the application of indirect pretensioning in open-air theatre roof in Koszalin is widely described in the domestic literature [3–5], a detailed discussion or study of this phenomenon cannot be found. There are few publications that focus on the general behavior of this venue [7, 9], excluding the study of the indirect pretension effects.

## **2. Scope and methods of analysis**

### **2.1. Scope of the study**

The study involved a numerical analysis of several cable net structure variants, designed in the shape of parabolic hyperboloid. The concepts differed

in the curvature of the cables and the method of pretensioning. The finite element analysis was performed with Autodesk Robot Structural Analysis software. The analytical study of structural models was divided into two stages.

The first stage of the study was carried out to select a more effective net shaping related to the value of cable sags. Different functions were used to vary the curvature geometry, which was expected to affect the internal forces and deformation of the net and the edge structure.

The second stage included the study of the selected cable structure with an application of indirect pretensioning method. This step involved the modification of the structure supports and implementation of cable stays. In opposition to the system inspired by the venue in Koszalin, an alternative concept based on the application of indirect pretensioning was introduced.

## 2.2. Geometric parameters of structures

The analysed structure was designed as a cable net system, which can fulfill the function of a roof over an open-air arena. The cable net formed a shape of parabolic hyperboloid in space and took an oval shape in plan view. The covered area was determined by the maximum theoretical width and length of the structure in plane, which was 36.9 and 71.0 meters, respectively.

The overall dimensions of the roof arose from the edge structure, which was similar in all variants. It consisted of two circular arch-curved beams made of CHS 914x25 sections, with 19.0 m rise and 71.0 m span. The arches were inclined at an angle of 30 degrees to the horizontal plane. The members were initially spaced 4.0 m apart in supporting points, considering the technological aspects of foundation (Fig. 2.a). For the purposes of numerical analysis, the arches were lengthened to the points of intersection, which created two supporting points.

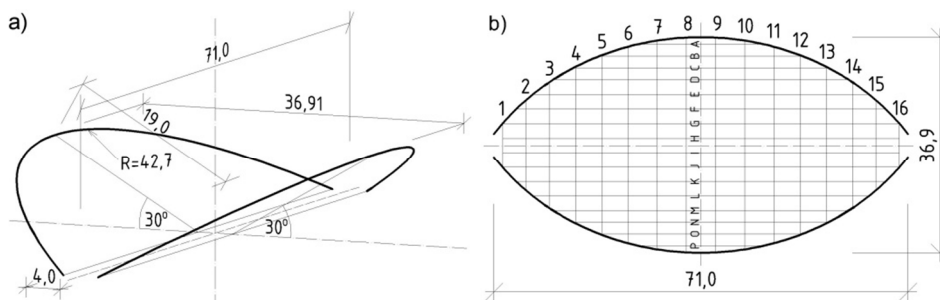

Fig. 2. The structural arrangement of the a) edge arches in axonometric view and b) cable net system in plan view

The cable net arrangement in plan view was similar in all concepts. It consisted of sixteen suspension cables and sixteen pretension cables, oriented in transverse and longitudinal direction, respectively (Fig. 2.b). The structural

system induced natural sag of suspension cables and the opposite curvature of pretension cables. The cross-sections for these groups were varied. Fully locked cables with a diameter of 50 mm and IPE 160 sections were assigned to suspension and pretension members, respectively. The application of rigid profiles was inspired by the construction of open-air theatre roof in Koszalin. This solution was investigated in a research paper [7], in which the implementation of I-profiles was assessed positively in terms of the impact on global behavior of system under snow load.

The structure selected for the second stage of the analysis was implemented with stays or columns, depending on the variant. These members supported the edge beams and provided self-balance for the structure. Cables with a diameter of 50 mm were adopted for stays. The columns were built from CHS 914x25 members. The summary of cross-sections for all structural members is presented in Table 1.

Table 1. Summary of cross-sections adopted for structural members

Type of member	Profile/ Section	Area of cross-section	Moment of inertia about horizontal axis	Moment of inertia about vertical axis
		$A$	$I_y$	$I_z$
		$[\times 10^2 \text{ mm}^2]$	$[\times 10^4 \text{ mm}^4]$	$[\times 10^4 \text{ mm}^4]$
Pretension cables	IPE 160	20.1	869	68.3
Suspension cables	Ø50 cable	16.5	-	-
Edge beams	CHS 914x25	698.22	690317	690317
Stays	Ø50 cable	16.5	-	-
Columns	CHS 159x10	46.8	1305	1305

### 2.3. Load application

Limited number of load types was introduced in order to investigate and compare the effects of pretensioning in the analysed structures. The cable roof system was subjected to:

- Pretensioning forces “P”,
- Dead load “G”,
- Snow load “S”.

The pretensioning of the cable net system was introduced as “P” load case. The pretensioning forces application was done through initial shortening of the cable specified by the relative dilatation command in the software. In the first stage of the study, in which comparative analysis of the net shaping was carried out, pretensioning forces were directly applied to sixteen suspension roof cables. In the second stage, where the phenomenon of indirect pretensioning was investigated, the forces were subjected only to the implemented cable stays. This action was performed to induce the outward rotation of simply supported edge arches and resulted in pretension of the roof cables.

The dead load, involving the weight of roof construction materials and the structure, was presented as “G” case. The uniformly distributed load applied to the roof was estimated on the basis of the designed roofing layers. The characteristic value of this surface load equaled  $0.22 \text{ kN/m}^2$ . The weight load of structural members was generated automatically in the software on the grounds of the defined cross sections.

The snow load “S” was represented by downward load applied to the roof surface. Due to complicated geometry of the roof, the shape and value of snow load was approximated from formulas dedicated to mono-pitched roofs. It was defined by uniformly distributed surface load acting on the whole surface of the roof. The load value was calculated assuming the 3<sup>rd</sup> snow zone specified in the National Annex of EN 1991-1-3 and maximum value of shape coefficient [10]. As a result, the characteristic value of snow load equaled  $0.96 \text{ kN/m}^2$ .

#### **2.4. Materials and methods of numerical analysis**

The numerical models of the structures were built from two types of elements. The cable members were modelled as cable type element provided by the Autodesk Robot Structural Analysis. These kind of elements had no flexural or compressive stiffness and transferred tensile forces only. They obtained simple connections on the ends by default in the model. Bar elements were used in other members, which possessed certain flexural stiffness. The structure was modelled segmentally, where the number and length of elements resulted from the arrangement of nodes in the cable net.

The linear elastic model of steel was adopted for all members in the structure. The yield point of the steel was set at 355 MPa for bar and 870 MPa for cable elements. Young’s modulus assigned to cable and bar elements equaled 160 and 210 GPa, respectively.

The response of structural models was received through non-linear analysis applied in Autodesk Robot Structural Analysis. The analysis included the second-order and third-order effects by utilizing P-delta and large displacement options in the software. The calculations were performed using incremental method with 30 load increments and maximum of 40 iterations for one increment. The non-linear problem was solved with the Full Newton-Raphson method, defined by the maximum update after each subdivision and iteration. In order to improve the convergence of the method, the “line search” algorithm with maximum of 5 trials was used.

#### **2.5. Basis of comparison**

The study was divided into two parts, in which different attributes were investigated. The comparison of concepts on each stage of analysis was carried out on the basis of internal forces distribution, form of deformation and numerical model stability.

The comparative study of concepts focused on the results obtained from two cases of loading:

- characteristic value of pretensioning forces (1.0P),
- characteristic combination of introduced loads (1.0P+1.0G+1.0S).

For the purposes of the analytical study, the “P” load case was detached from dead load “G”, despite standard recommendations [11]. On this basis, the impact of various pretensioning and effects of further gravity load inclusion were investigated separately. The characteristic load combination was introduced to obtain the actual displacement values, which played a crucial role in the analysis of results. In order to limit the number of the presented cases, the design load combination was omitted in the study.

### 3. Analysis of cable net shape

#### 3.1. Determination of net shape

The investigation of indirect pretension application was preceded by the comparative analysis of net shaping. At this stage, pretension of the structures was achieved by direct application of initial forces to the roof suspension cables. The edge arches were fixed at both ends, which provided the self-balance for the structure. Two concepts of net geometry differing in the value of sags were considered.

The first geometry was determined on the basis of the assumed sag equaled 2.5 m in the saddle point of the surface. This value represented the sag of the longest suspension cables no. 8 and 9, which were anchored close to the keystones of the edge arches (Fig. 1.b). Consequently, the calculated sag-to-span ratio is approximate to the upper recommended limit of 6% [1]. The suspension cable geometry was defined by the catenary curve (Fig. 3), which was described by the formula:

$$f(y) = z = a \cdot \cosh\left(\frac{y}{a}\right) = a \cdot \frac{e^{\frac{y}{a}} + e^{-\frac{y}{a}}}{2} \quad (1)$$

where the value of parameter  $a$  was estimated iteratively according to the assumed sag of the longest cable from the equation:

$$f_1 = f(y) - a = a \cdot \cosh\left(\frac{y}{a}\right) - a = a \cdot \frac{e^{\frac{y}{a}} + e^{-\frac{y}{a}}}{2} - a \quad (2)$$

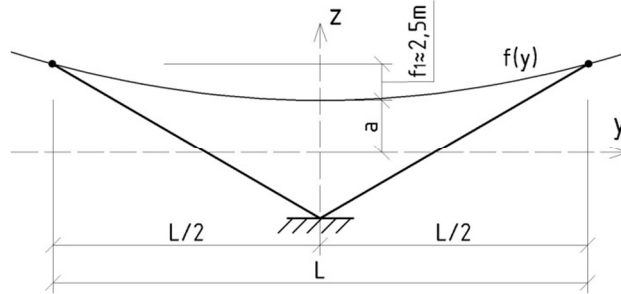

Fig. 3. Determination of the cable curve for the 1<sup>st</sup> concept of net shaping

The geometry of other suspension cables was obtained through rescaling of the cable curve obtained for the longest members. The curvature of pretension cables resulted from the suspension cable shaping, which set the vertical position of the net nodes. The structural model of the 1<sup>st</sup> net shaping concept is presented in Fig. 4.

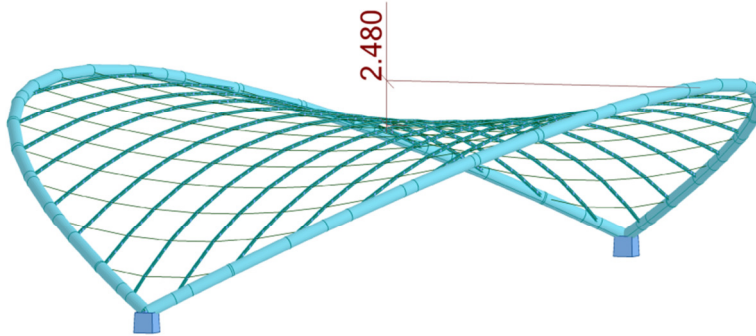

Fig. 4. View of the structural model without roof panels representing the 1<sup>st</sup> concept of net shaping

In the second concept, net geometry was determined to obtain a curvature of suspension cables so that the planes of the edge arches were tangent to them in the anchor points (Fig. 5). The aim of this action was to eliminate the out of plane bending of the arches, which depended on the direction of the forces transferred from the suspension cables. Considering the nonlinear behaviour of cable members, a certain reduction of the bending moments was expected. In this case, the suspension cable geometry was defined by the parabola curve (Fig. 5), which was described by the formula:

$$f(y) = z = a \cdot y^2 \quad (3)$$

where  $a$  was calculated on the basis of the assumed tangency point from the derivative of the parabola function:

$$f'(y) = \frac{dz}{dy} = 2ay = tg(\alpha) \quad (4)$$

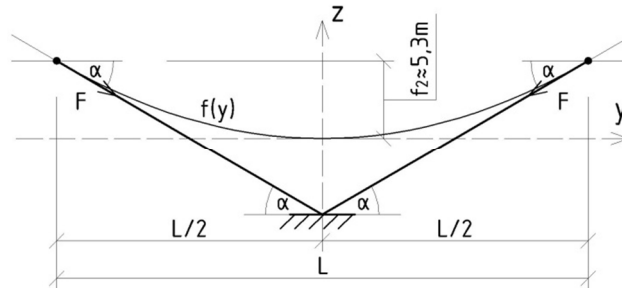

Fig. 5. Determination of the cable curve for the 2<sup>nd</sup> concept of net shaping

The sag of the longest cable in the saddle point was calculated from the equation (4) and approximate to 5.3 m. As in the previous concept, the geometry of pretension cables resulted from the determination of suspension cables shape. The structural model of the 2<sup>nd</sup> concept of geometry is shown in Fig. 6.

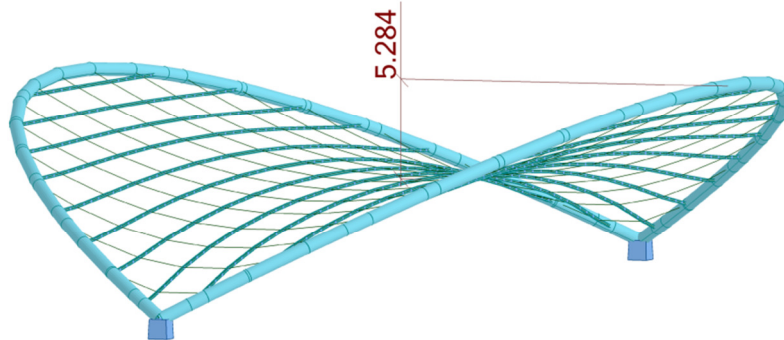

Fig. 6. View of the structural model without roof panels representing the 2<sup>nd</sup> concept of net shaping

### 3.2. Assumptions of pretensioning

The comparison between different net shaping was made on the assumption of approximately similar axial forces in the suspension cables under load combination. It was achieved by adjusting the values of initial shortening of the considered members. In this regard, the values of relative dilatation (shortening) for all 16 suspension cables varied between:

- 0.005 ÷ 0.012 in the 1<sup>st</sup> net concept;
- 0.0008 ÷ 0.0012 in the 2<sup>nd</sup> net concept.

### 3.3. Results

Several diagrams of internal forces and deformation for suspension cables and edge beams, considering the 1<sup>st</sup> and 2<sup>nd</sup> concept of net shaping are presented in Fig. 7–11. The summary of internal forces and displacement values are given in Table 2.

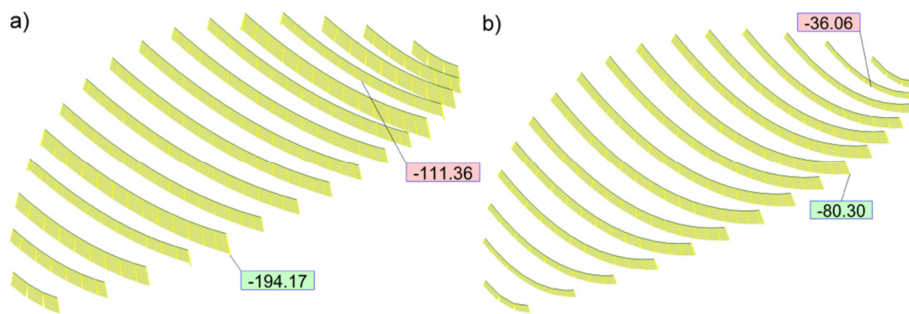

Fig. 7. Axial forces  $N_x$  in suspension cables for a) 1<sup>st</sup> and b) 2<sup>nd</sup> net shape (1.0P)

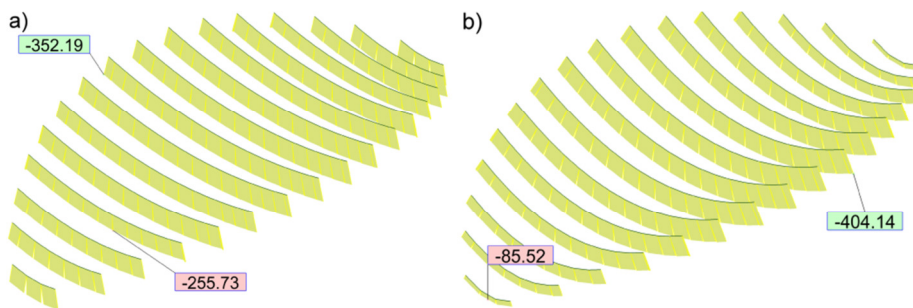

Fig. 8. Axial forces  $N_x$  in suspension cables for a) 1<sup>st</sup> and b) 2<sup>nd</sup> net shape (1.0P+1.0G+1.0S)

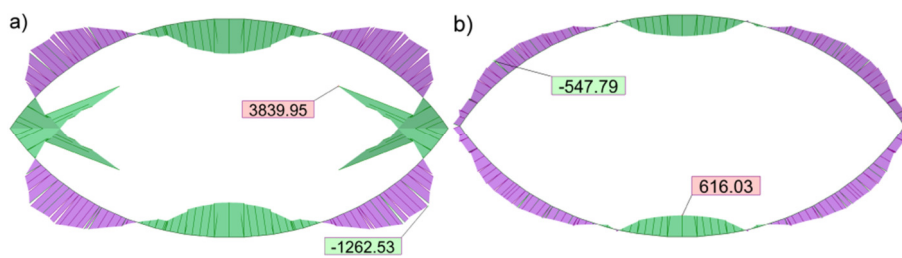

Fig. 9. In plane bending moments  $M_y$  in edge beams for a) 1<sup>st</sup> and b) 2<sup>nd</sup> net shape (1.0P+1.0G+1.0S)

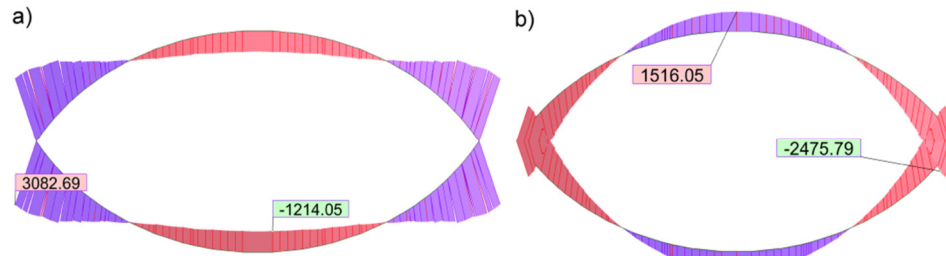

Fig. 10. Out of plane bending moments  $M_z$  in edge beams for a) 1<sup>st</sup> and b) 2<sup>nd</sup> net shape (1.0P+1.0G+1.0S)

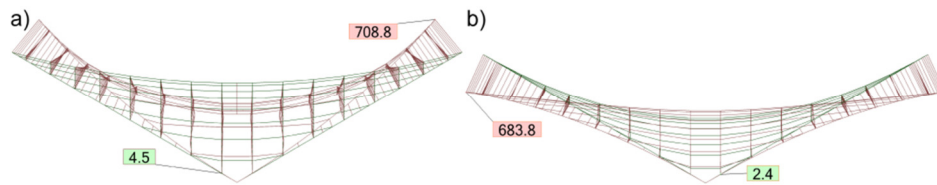

Fig. 11. Deformation of the structure for a) 1<sup>st</sup> and b) 2<sup>nd</sup> net shape (1.0P+1.0G+1.0S)

Table 2. Summary of internal forces and displacement values from net shaping analysis

Load case	No. of net shape	Number of pretensioned cables	Sag in the saddle point	Suspension cables		Edge beams			
				Mean tensile force	Max. vertical deflection	Max. compressive force	Max. in plane bending moment	Max. out of plane bending moment	Max. keystone displacement
			$f_i$	$N_{X,MEAN}$	$\Delta_{V,MAX}$	$N_{X,MAX}$	$M_{Y,MAX}$	$M_{Z,MAX}$	$\Delta_{MAX}$
			[m]	[kN]	[mm]	[kN]	[kNm]	[kNm]	[mm]
Pretensioning forces 1.0P	1.	16	2.5	138.7	31.3	-1630.4	420.0	3846.9	-626.0
	2.	16	5.3	64.7	-113.9	-844.04	-1437.2	-1495.5	405.8
Load combination 1.0P+1.0G+1.0S	1.	16	2.5	313.2	534.2	-3718.1	3840.0	3082.7	-708.8
	2.	16	5.3	317.5	-119.4	-3685.2	616.0	-2475.8	683.8

### 3.4. Discussion

The results showed that suspension cables in the 1<sup>st</sup> net geometry required approximately twice as large pretensioning forces as the alternative concept in order to obtain comparable tensile forces under load combination. The same values of axial forces in these members under pretension case only were unable

to be achieved. This might be due to different net shaping, which induced diverse internal force distribution and global behaviour of the numerical model.

The analysis indicated proportional relationship between tensile forces in suspension cables and compressive forces in the edge beams in all cases. In contrast, the distribution and values of bending moments were varied. The pretension induced larger in plane bending moments in the 2<sup>nd</sup> concept, while the inclusion of gravity load caused the opposite trend. The largest difference was observed in case of load combination, where the maximum value in the 2<sup>st</sup> concept was 84% smaller comparing to the 1<sup>st</sup> variant. The diverse net shape resulted in opposite distribution of out-of-plane bending moments. Maximum values obtained with the 2<sup>nd</sup> net geometry were 20–61% smaller in relation to the 1<sup>st</sup> version. In general, the 2<sup>nd</sup> concept of net shape appeared to be more effective in terms of overall bending in the edge arches.

Significant impact of net shaping was observed in the deformation view of the structures. The 1<sup>st</sup> structure showed downward deflection of roof cables, followed by inward displacement of edge beams. In this case, potential implementation of cable stays would counteract the inward folding and provide balance as well as greater model stability. In contrast, the analysis indicated an undesired outward displacement of the edge beams and upward deflection of the cable net in the 2<sup>nd</sup> alternative. This form of deformation disqualified the 2<sup>nd</sup> concept in view of further implementation of pretensioned cable stays. On this basis, the 1<sup>st</sup> concept of net shape was selected for the main part of the study, in which the simulation of indirect pretensioning was performed.

## **4. Analysis of structures with indirect pretensioning**

### **4.1. Adaptation of the structure**

The structural model with the selected net shape was implemented with 12 cable stays with a diameter of 50 mm, fixed to the edge beams (Fig. 12.a). Different levels of anchor points were designed to provide integration into a slope of a potential grandstand. At this stage of analysis, both edge beams were simply supported (Fig. 12.b). This modification was necessary to perform indirect pretensioning of roof cables, which is caused by the outward rotation of arches. Balance of the structure was provided by the implemented stays, which became the only cable members subjected to shortening. The described adaptation of the system was inspired by the discussed cable-roof structure in Koszalin. This variant is introduced as the 1<sup>st</sup> concept of indirect pretensioning in the study. Views of the structural model representing this concept are shown in Fig. 13.

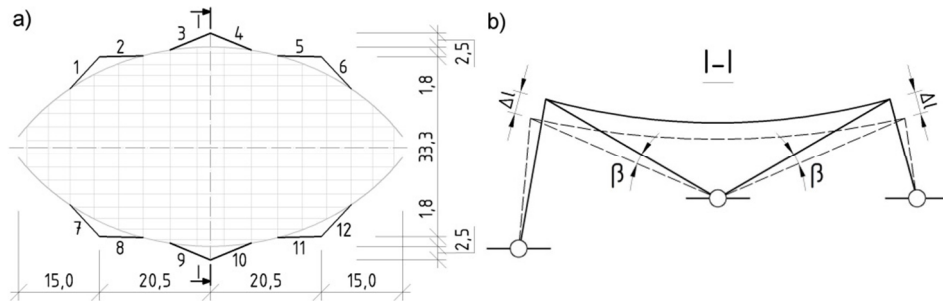

Fig. 12. Views of the structure showing a) the arrangement of cable stays in plan and b) simplified static scheme in cross section considering 1<sup>st</sup> concept of indirect pretensioning

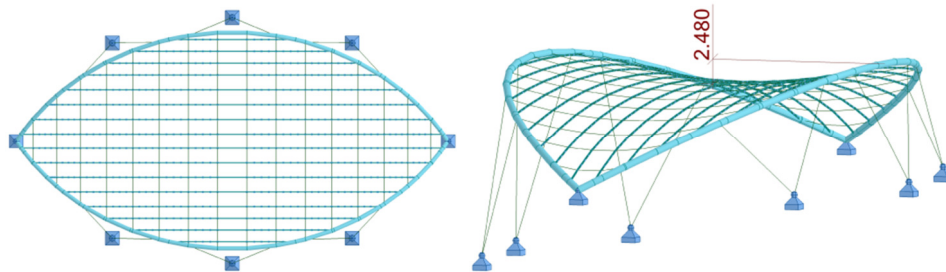

Fig. 13. Views of the structural model without roof panels representing the 1<sup>st</sup> concept of indirect pretensioning

The 2<sup>nd</sup> concept of indirect pretension assumed stiffening of the supporting structure and reducing the number of cable stays. The alternative version retained the arrangement of net shape and stays, whilst the supporting conditions were modified. The group of shorter cable stays no. 7–12 was replaced by CHS 159×10 members (Fig. 14.b). Furthermore, the stiffened edge beam received fixed supports (Fig. 14.a). In this case, the indirect pretension action was simulated by the limited group of 6 longer stays, fixed to the simply supported arch (Fig. 14.a).

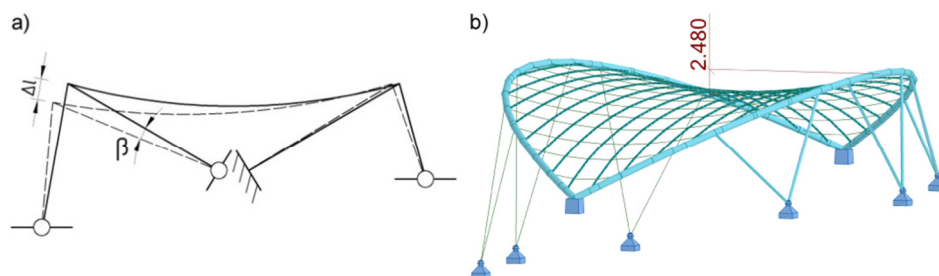

Fig. 14. 2<sup>nd</sup> concept of indirect pretensioning represented by a) simplified static scheme in cross section and b) view of structural model without roof panels

## 4.2. Assumptions of pretensioning

At this stage of the study, suspension cables were free of initial shortening in the software. This operation was performed on the implemented cable stays, where the values of relative dilatation were set on the same level in both versions. This parameter was adjusted in order to obtain comparable deflection of cables under load combination in reference to the results of the net shaping analysis. In this regard, the values of this parameter equaled:

- 0.008 in long and 0.012 in short stays in the 1<sup>st</sup> pretension concept,
- 0.008 in long stays in the 2<sup>nd</sup> pretension concept.

The prestress applied to the cable stays led to the outward rotation of the simply supported arches. The difference between the original and final position of the edge beams was described by the  $\beta$  angle of rotation and approximate to:

- 0.5° in the 1<sup>st</sup> pretensioning concept,
- 0.4° in the 2<sup>nd</sup> pretensioning concept.

## 4.3. Results

Several diagrams of internal forces and deformation for cable stays, suspension cables and edge beams, considering the 1<sup>st</sup> and 2<sup>nd</sup> concept of indirect pretension are presented in Fig. 15–20. The summary of internal forces and displacement values is given in Table 3.

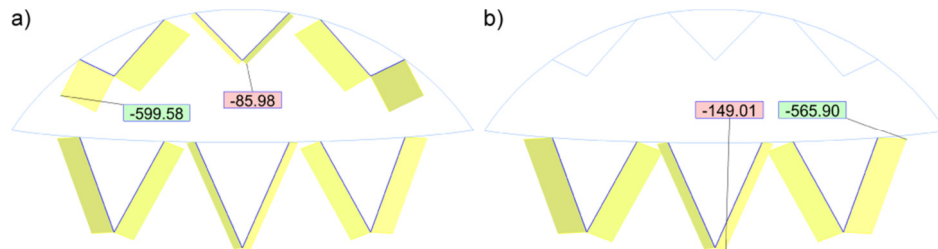

Fig. 15. Axial forces  $N_X$  in cable stays for a) 1<sup>st</sup> and b) 2<sup>nd</sup> pretensioning concept (1.0P)

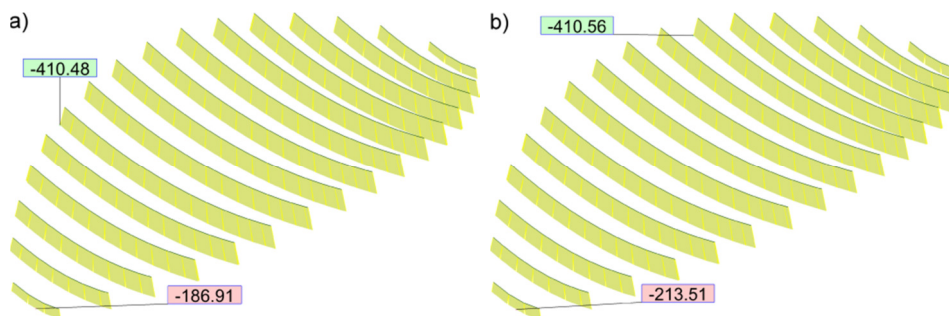

Fig. 16. Axial forces  $N_X$  in suspension cables for a) 1<sup>st</sup> and b) 2<sup>nd</sup> pretensioning concept (1.0P)

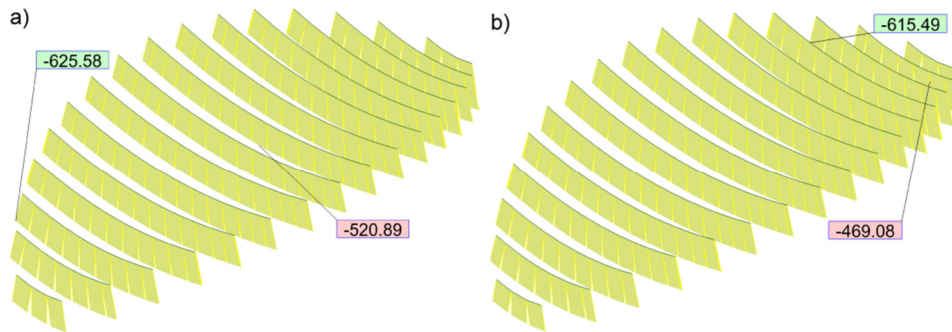

Fig. 17. Axial forces  $N_x$  in suspension cables for a) 1<sup>st</sup> and b) 2<sup>nd</sup> pretensioning concept (1.0P+1.0G+1.0S)

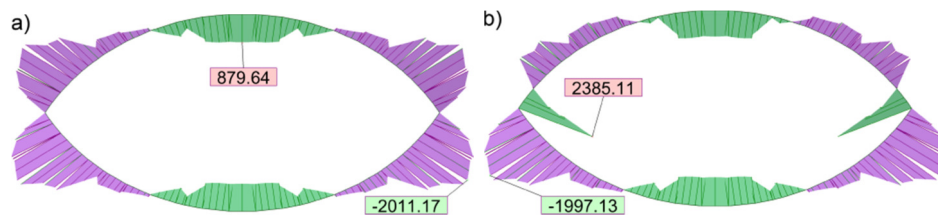

Fig. 18. In plane bending moments  $M_y$  in edge beams for a) 1<sup>st</sup> and b) 2<sup>nd</sup> pretensioning concept (1.0P+1.0G+1.0S)

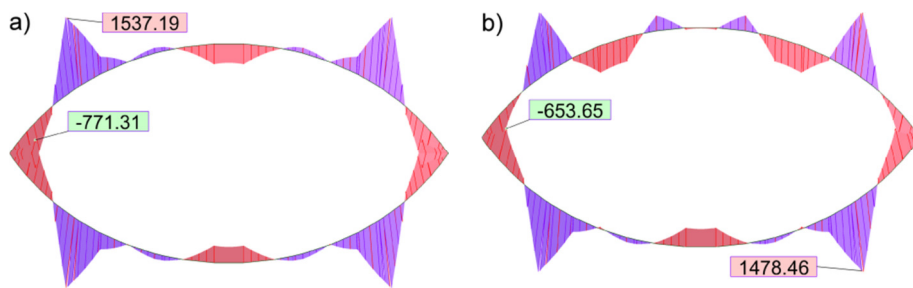

Fig. 19. Out of plane bending moments  $M_z$  in edge beams for a) 1<sup>st</sup> and b) 2<sup>nd</sup> pretensioning concept (1.0P+1.0G+1.0S).

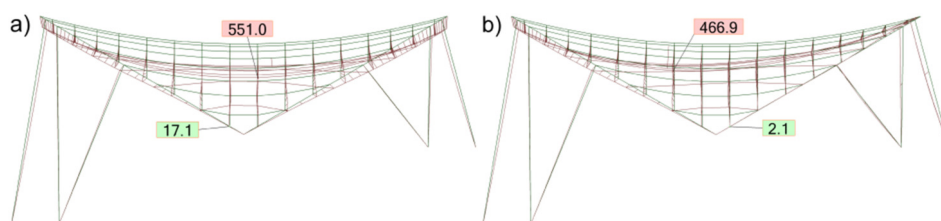

Fig. 20. Deformation of the structure for a) 1<sup>st</sup> and b) 2<sup>nd</sup> pretensioning concept (1.0P+1.0G+1.0S)

Table 3. Summary of internal forces and displacement values from indirect pretensioning analysis

Load case	No. of pretensioning concept	Number of pretensioned stays	Stays	Suspension cables			Edge beams			
			Max. tensile force	Mean tensile force	Max. vertical deflection	Max. compressive force	Max. in plane bending moment	Max. out of plane bending moment	Max. keystone displacement	
			$N_{X,MAX}$	$N_{X,MEAN}$	$\Delta V_{MAX}$	$N_{X,MAX}$	$M_{Y,MAX}$	$M_{Z,MAX}$	$\Delta_{MAX}$	
			[kN]	[kN]	[mm]	[kN]	[kNm]	[kNm]	[mm]	
<b>Pretensioning forces 1.0P</b>	1.	12	599.6	379.5	-59.0	-4162.2	450.7	867.3	197.1	
	2.	6	565.9	381.9	-132.3	-4155.2	465.2	-1134.8	166.7	
<b>Load combination 1.0P+1.0G+1.0S</b>	1.	12	847.3	564.0	551.0	-5921.6	-2011.2	1537.2	202.3	
	2.	6	753.6	565.4	466.9	-5820.8	2385.1	1478.5	175.4	

#### 4.4. Discussion

The results showed that despite the reduction of prestressed stays, the structure representing the 2<sup>nd</sup> concept responded with approximately equal axial forces in suspension cables comparing to the 1<sup>st</sup> solution. In both variants, these values showed a proportional relationship under introduced load cases. This trend may be considered similar regarding cable stays.

Compression of the edge beams was proportional to the tensile forces in cables and similar in both concepts. Minor differences appeared in the bending moment values due to the implementation of fixed supports in one of the edge beams in the 2<sup>nd</sup> pretension concept. Maximum difference was observed for the in-plane bending moment under characteristic load combination. In this case, the value in the 2<sup>nd</sup> concept was 20% greater in reference to the 1<sup>st</sup> variant. Apart from this, the analysis indicated comparable bending moment distribution along the arches span.

The deformation forms differed due to the applied pretensioning method. The 1<sup>st</sup> concept showed similar displacements in both arches, whilst the deformation view representing the alternative was slightly asymmetrical. This behaviour resulted from stiffening one of the edge beams, which retained its position under the applied load. However, the maximum values of displacement for each member occurred to be smaller in the 2<sup>nd</sup> variant. The application of this modified method caused a reduction of cable net deflection up to 15% in relation to the 1<sup>st</sup> concept.

## 5. Summary and conclusions

In this paper, the results of the finite element analysis of several cable net roof structures are presented. The concepts were investigated in the aspects of structural net shaping and application of different pretensioning methods. In this regard, the analysis was divided into two stages. Each part involved the numerical study of two concepts of the structure, which represented different solutions in terms of the analysed aspects. The favourable variant of net shape constituted the geometrical basis for the further analysis of various pretension concepts. The presented applications were inspired by the indirect pretension performed during the completion of cable net roof over the open-air theatre in Koszalin. All of the introduced solutions were assessed on the basis of comparison of the system response under pretension and the inclusion of gravity load.

The results of the net shaping analysis of the self-balanced systems proved that the geometry of cables has significant impact on the behavior of the structure. The surface with typical sag-to-span ratio was compared to the proposed curvature of cables aimed to reduce bending of edge beams. The variants showed diverse response under considered load cases. Significant reduction of bending in the arches for the alternative geometry was achieved. Nevertheless, this concept appeared to be unfavourable in terms of further application of indirect pretension. Large sag of the surface in addition to nonlinear behavior of cables induced outward displacement of the arches, which eliminated the implementation of prestressed cable stays in further steps. Moreover, the deformation form showed an atypical upward deflection of the cable net under gravity load, which might disqualify this geometry as the solution for self-balanced supporting structure. On these grounds, the concept with typical sag to span ratio was selected as a base model for simulations of indirect pretensioning in the main part of the study.

The application of indirect way of pretensioning in cable net numerical models proved to be effective for the inspired concept as well as the introduced alternative, in which a reduced number of prestressed cable stays was responsible for the pretensioning of the cable roof. The numerical implementation of these solutions induced the assumed pretension of the cable net in the introduced systems. The results showed approximately similar values of internal forces distribution in both concepts. Greater maximum bending moment values were observed in some cases due to the implementation of fixed support in one of the arches. The application of the proposed method, aimed to limit the number of cable stays, gained favour in terms of model stability. Stiffening of the supporting structure resulted in smaller values of displacement for roof cables and edge beams in comparison to the application of unmodified method inspired by the completion of the cable roof in Koszalin.

The numerical verification of consecutive concepts led to a gradual reduction of directly prestressed members from 16 suspension cables to 6 cable

stays in the analysed roof. The idea presented in the final proposal might be beneficial in terms of complexity and time of roof erection, which depends on the process of prestressing cable members. Moreover, successful implementation of indirect pretensioning eliminates the need to use tensioning devices at great heights. The proposed method of stiffening one of the edge beams might be favourable in the aspect of roof construction. The self-balanced arch can support the whole cable system during the erection of the structure. Nevertheless, the introduced solution shall be investigated under upward action of wind, which may indicate problems with balance of this type of system. Such application shall also be analysed in view of stiffness of joints and supports in the structure. A wider parametric analysis of the net shape might also be considered in order to obtain optimal cables geometry in view of the applied pretensioning method.

### References

- [1] Buchholdt, H. A. An introduction to cable roof structures, second edition, Thomas Telford, London, 1999.
- [2] Pałkowski, S. Steel structures, Some issues of calculating and designing, Polish Scientific Publishers PWN, Warsaw, 2009 (in Polish).
- [3] Łubiński, M.; Żółtowski, W. Metal structures, Part 2, Arkady, Warsaw, 2004 (in Polish).
- [4] Pałkowski, S. Cable structures, Scientific-Technical Publishers WNT, Warsaw, 1994 (in Polish).
- [5] Kucharczuk, W.; Labocha, S. Steel structure halls, Designers guide, Polish Technical Publishers PWT, Rzeszow, 2012 (in Polish).
- [6] Jankowiak, W. Selected issues of steel structures, Part 2 – Tanks, Storage bins, Suspended structures, PUT Publishing House, Poznan, 1994 (in Polish).
- [7] Filipkowski, J.; Deska, K. Geometrical framework of a suspended structure and the state of displacement due to snow load, 25th International Conference on Structural Failures, Międzyzdroje, May 2011 (in Polish).
- [8] Bradshaw, R. History of the analysis of cable net structures, Proceedings of the 2005 Structures Congress and 2005 Forensic Engineering Symposium, New York, April 2005.
- [9] Pawłowski, W.; Deska, K. Registration of geometrical structure of suspended roof for example of the open-air theatre roof in Koszalin, Scientific Bulletin of Lodz Technical University: Civil Engineering, v. 60, no. 1052, Lodz University of Technology Press, Lodz, 2009, 97–105 (in Polish).
- [10] PN-EN 1991-1-3: 2005 Eurocode 1: Actions on structures – Part 1-3: General actions – Snow loads (in Polish).
- [11] EN 1993-1-11: 2006 Eurocode 3: Design of steel structures – Part 1-11: Design of structures with tension components.

*Przesłano do redakcji: 09.12.2019 r.*